

Uniclass	EPIC
L532:P511	E411:X52
CI/SfB	(43) Xi3



EQUITONE
Fibre cement facade materials



INSTALLATION
GUIDE
AUSTRALIA

www.equitone.com

Contents

Section 1	INTRODUCTION	4
Section 2	SITE WORK	6
Section 3	ACCESSORIES	8
Section 4	WORKING WITH EQUITONE	10
Section 5	INSTALLATION	16
Section 6	DESIGN CONSIDERATIONS	23
Section 7	MOUNTING SEQUENCE	30
Section 8	SUPPORTING FRAME DETAILS	33
Section 9	MAINTENANCE	41
Section 10	WARRANTY	42



About EQUITONE

EQUITONE is the world's leading architectural facade material. EQUITONE evokes the unique characteristics of fibre cement. Fibre cement is a mineral composite with outstanding physical and aesthetic properties. Our company has led development and innovation of this versatile architectural building board for more than a century, under different brands names such as "Eternit". Today, EQUITONE is manufactured in state-of-the-art facilities in Germany and Belgium.

This guide illustrates that installation of the EQUITONE range of fibre cement panels is relatively simple and convenient, provided some simple rules are followed.

The information in this guide is comprehensive but not exhaustive. More information is available through the experienced and knowledgeable EQUITONE service teams.

All design and construction of facade systems must be in strict accordance with the latest version of Building Code of Australia standards and regulations.

As an installer of this material it is important to note that the panels are pre-finished. Professional care and attention is therefore needed to ensure an acceptable level of installation is consistently achieved.

Disclaimer

The information in this guide is correct at the time of printing. However, due to a programme of commitment to continuous product and system development, the company reserves the right to amend, alter or change the information contained herein without prior notice. Please contact the local, official EQUITONE sales representative for the current version, available upon request.

Ventilated facade

A ventilated facade is a kind of two stage construction, an inner structure with a protective outer skin, the cladding panel. This skin protects the structure against the elements. A ventilated facade is ideal for use in both new buildings and renovation projects.

The key features of a ventilated facade are:

- an outer skin of panels,
- an air gap or cavity, and
- an insulated backing wall that controls air leakage.

The panel shields the backing wall from the weather. However, depending on the nature of the joints between panels, some water penetration may occur. The air gap and airtight backing wall combine to limit this penetration. The cavity space can evaporate and/or drain moisture away safely. Therefore, providing a secondary line of defence against the elements. See page 24 for more information.



Drained and ventilated principle

Drained and ventilated systems are provided with openings at the top and bottom of the wall. These provide both ventilation and an effective drainage route. This combination allows air to circulate and dry the cavity between the inner and outer skins.

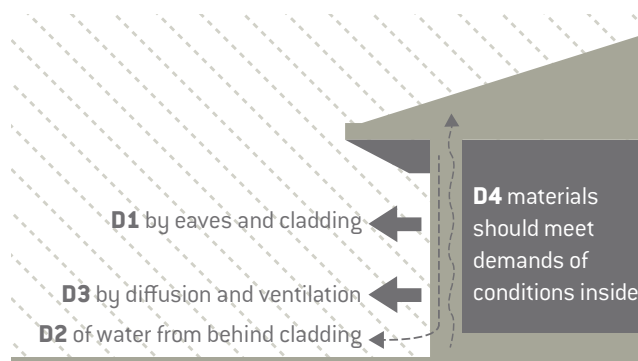
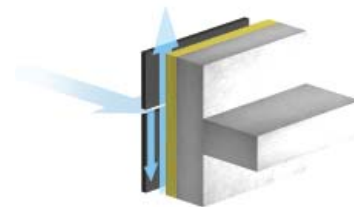

D1 Check claddings and flashings for deflection (aim to keep water out).

D2 Arrange for drainage to channel outside (if water gets in).

D3 Arrange for ventilation and vapour diffusion drying (to eliminate remaining water).

D4 Choose components that are durable for prevalent conditions (and avoid damage during drying process).

Health and safety

All EQUITONE panels have their own Material Safety Data Sheets. These MSDS outline common hazards associated with working with the panels and provide measures to minimise risk.

For more information, please refer to page 12. Material Safety Data Sheets are available upon request.

Storage

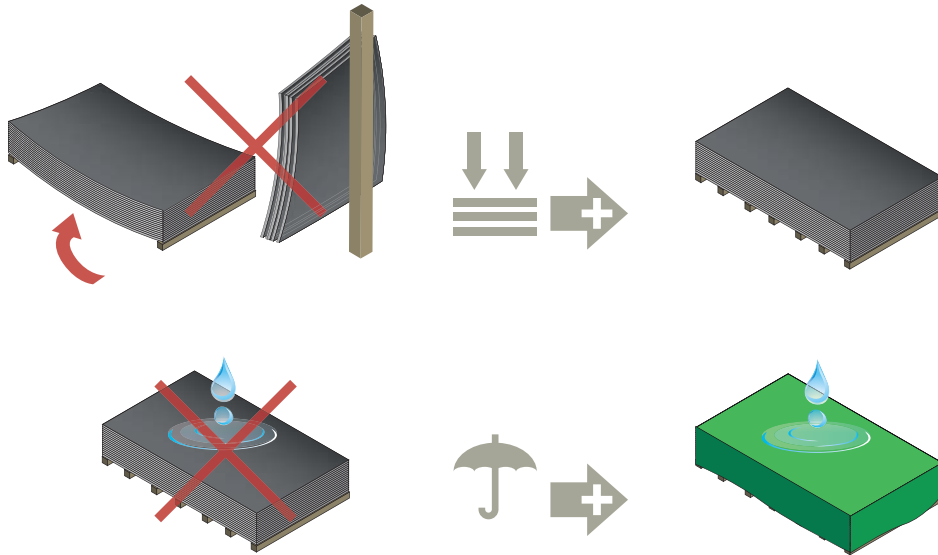

1. All panel materials must be stored flat on pallets, inside and undercover in dry conditions, protected from weather and potential influence of other trades.
2. Stack the pallets in a way so that the panels are ventilated.
3. Do not deliver any panels to site which cannot be installed immediately or unloaded into a suitable well protected storage area.
4. Store products clear of the ground and on level bearers at a maximum of 600mm centres.
5. Individual stacks can be 500mm high, and not more than five stacks can be placed on top of one another.

NOTE: EQUITONE coated panels are supplied with protective paper between the decorated faces. This protection should not be removed. Stack the panels' front face or rear surface-to-rear surface. The panels should not be placed face-to-back.

Handling

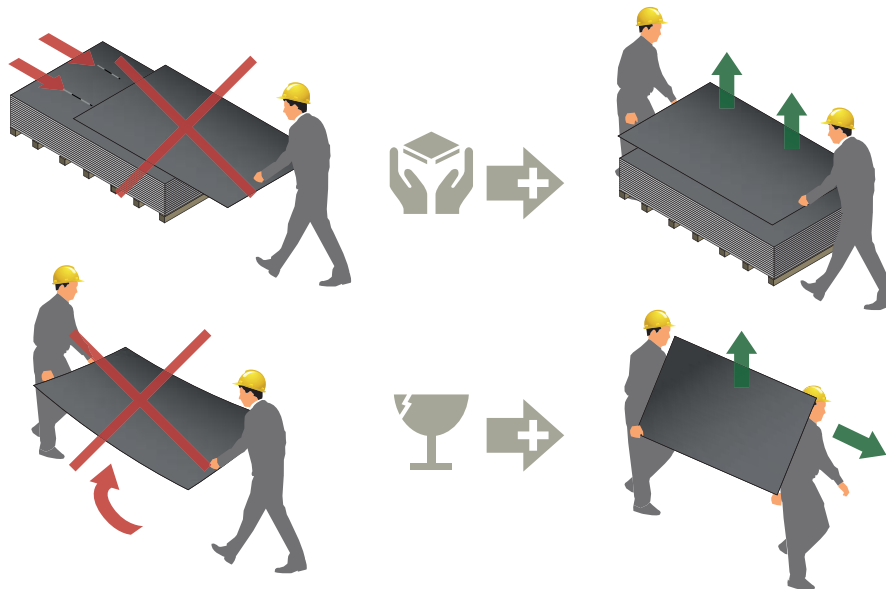

1. Always lift panels off each other, never slide them over one another, since scratching may occur.
2. To carry the panels, stand them on their back edge and lift with two people (one person at each end) protecting the face from scratching or damage.

NOTE: Always lean panel towards back edge to avoid damaging visible front edge. The use of soft bearers is helpful the rest the panel edge on and minimise possible damage.

Transport

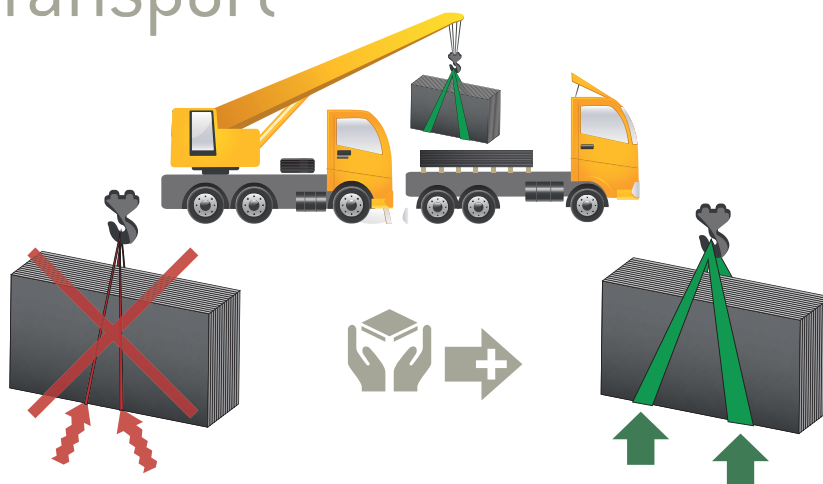

1. Moving panels that are stacked on pallets should be done with a forklift or a crane.
2. Use wide lifting straps or forklift with wide arm setting.

Ensure panels are secured to pallet in a way that will not cause damage to panels. Stacks should be transported under a waterproof cover.

Centralising tool

This accessory fits any standard manual or electrical drill and is used with all EQUITONE panels which are to be fixed to a metal supporting frame.

The use of this tool ensures that the smaller rivet hole in the vertical profile is centered in the larger panel hole. This ensures the best allowance for any frame movement.

The tool has a guide that neatly fits into the panel hole. The drill bit then extends to drill the profile. The drill bits can be easily replaced at the end of their functional life.



Foam tape

Foam tape is used when fixing EQUITONE to metal support frames. It is a closed cell PVC foam tape and comes with a self-adhesive strip. The tape has a number of functions:

- It reduces moisture infiltration at vertical joints.
- It fills space between panel and rivet.
- Cushions panel against sudden impact.
- Allows additional flexing movement of the frame.
- There is space available for fitting horizontal joint profile or backing strips without causing panel distortion.
- It separates panel from metal frame, reducing risk of surface condensation forming on cool mornings.

Different widths of tape can be employed. Wider tapes also have the extra benefit of “blacking out” the vertical joint without needing to use additional tape or paint. Ensure tape is thick enough to provide an adequate seal.



EQUITONE Astro rivet

The stainless steel (quality A2, AISI 304) EQUITONE Astro rivet has a coloured head to match the panel and built-in spacer (cylinder).

The stainless steel spacer/cylinder maintains a consistent gap between panel and metal frame, and allows total free movement of the panel. An uncoated rivet is also available.

Failure to use this rivet invalidates product warranty.



Rivet sleeve

Rivet sleeves are used with rivets to form fixed points when fixing panels. The sleeve slides over rivet and fills the hole in the panel.



Panel cutting

As much pre-cutting of panels as possible should be accomplished off-site. In situations, where this is not possible – for reasons of time, geography or logistics, for example – on-site working can be achieved in a specially prepared area.

It is recommended that EQUITONE saw blades are employed to cut EQUITONE panels on and off-site. These blades are especially designed for fibre cement and when correctly used result in a high level of finish. The blade is unique with its minimal diamond tipped teeth which are shaped to give a tear-free edge. The EQUITONE blade's vibration damping composite body also assists in achieving optimum cut results.

Blade diameter	Blade thickness	Borehole	Number of teeth	Saw speed
160mm	3.2mm	20mm	4	4,000rpm
190mm	3.2mm	20mm	4	3,200rpm
225mm	3.2mm	30mm	6	2,800rpm
300mm	3.2mm	30mm	8	2,000rpm

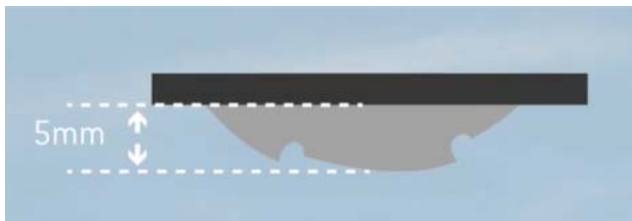

EQUITONE blades remain good up to 5,000m of cutting if correct procedures are observed, including:

- panel faces down,
- panel is held firmly in place to minimise vibration,
- saw blade reaches 5mm below panel thickness,
- set correct speed relative to recommended saw blade size, and
- one panel is cut at one time.

Cutting curved cut-outs

Curved cut-outs also required special procedures. These include:

- panel must face down,
- drill hole in panel at edge of intended curved cut-out area,
- ensure jigsaw pendulum function is switched off, and
- insert Bosch T141HM jigsaw blade and proceed to cut.

NOTE: Poorly maintained cutting tools or incorrect saw speed as opposed to blade speed can result in localised heating/burning of panel edges. Do not use grinder tools as these usually have a high cutting speed. This produces higher than average pressure on panel edges. Most grinding tools also produce excessive, unwanted dust.



Edge treatment

It is advisable to sand edges of panels after cutting panels to size. This reduces possibility of damage and improves panel edge appearance.

1. Use 80-grit sand paper.
2. Affix sheet of sand paper to a block of scrap wood or building board approximately 400mm x 100mm in size and use to sand edges.

Dust removal



Cutting or drilling creates dust which contains cement. If allowed to dry in, this dust can permanently stain the surface of the panels. Immediately after cutting or drilling, clean and dispose all dust particles in the recommended manner, as follows:

1. When dry, remove all dust with a micro-fibre or micro-soft clean cloth.
2. If dust is present on damp panels, remove dust with soft brush and plenty of water.

RECOMMENDATION: Do not drill panels when panels are positioned on facade as dust is likely to spread over large areas.

As with all products containing quartz, e.g. concrete and clay, when EQUITONE panels are machined mechanically (cutting, sanding, drilling) the released dust may contain quartz particles. Inhalation of high concentrations of dust may irritate the airways, and dust may also cause irritation of eyes and/or skin. Inhalation of dust containing quartz, especially fine (respirable size) particulate matter, in high concentrations over prolonged periods of time, can lead to lung disease (silicosis) and an increased risk of lung cancer.

1. Avoid dust inhalation with the use of cutting/sanding equipment fitted with dust extraction/suppression accessories and wherever practical.
2. Ensure adequate ventilation of all work sites.
3. Avoid contact with eyes and skin by wearing an approved respirator (dust mask of at least Type P2) together with appropriate personal protective equipment (helmet, goggles, boots and protective clothing).

Luko

With semi-transparent coatings like those used on EQUITONE [natura] and [natura pro] panels, moisture ingress at the panel edges and predrilled holes can become apparent. In wet weather, edges can assume a darker shade.

This colouration will fade and disappear over time. It is unlikely to re-occur but the length of time depends on seasonal weather trends.

To help prevent this phenomenon from occurring, the edges of all factory-cut EQUITONE [natura] and [natura pro] panels are impregnated with Luko edge sealant at the factory. The edges of EQUITONE [natura] and [natura pro] panels that have been cut on-site must then also be impregnated with Luko.

The following procedure is recommended:

1. Apply Luko in ambient temperatures between 5°C and 25°C.
2. Treat one panel at a time.
3. Pour adequate amount of Luko into reservoir of tray.
4. Use sponge applicator, dip into liquid and remove any excess.
5. Start at one side of the panel and angle applicator away from face of the panel.
6. Simply run applicator along panel edge.
7. Ensure full coverage of edge.
8. Repeat process if necessary.
9. Immediately wipe away any excess Luko that appears on panel surface.
10. Do not apply Luko in wet conditions or after panel is fixed into position.



Panel drilling

Panels should be drilled carefully using the specially designed EQUITONE fibre cement drill bit. This drill bit is a fully hardened steel bit with a cutting edge to suit fibre cement. This reduces risk of sliding on panel surface, provides a clean cut (no burrs or burning) and has a very long life.



Illustration at right indicates differences between a typical EQUITONE drill bit and standard masonry drill bits. Standard masonry drill bits produce fine dust, burning of the fibre cement and a distorted drill aperture.





For drilling to produce quality and consistent results, it is wise to observe some standard procedures, as follows:

- panel face up,
- carefully and clearly mark hole positions on face of panel,
- drill all holes with recommended EQUITONE drill bit,
- best drill quality achieved on solid workbench,
- do not drill multiple panels but one panel at one time to ensure accurate positioning of drill holes, and
- immediately clean all dust and pencil marks from panel.

RECOMMENDATION: On darker coloured panels, the use of red or white pencils makes clear identification of cut lines and drill hole positions easier.

Stain removal

EQUITONE [natura], [natura pro] and [pictura]

Stains can be removed by normal washing with mild detergents or soap solutions (e.g. dishwashing detergent) and a sponge. The use of abrasive materials – such as steel wool and scouring powders/liquids etc – is not permitted as these cleansing agents will cause irreparable surface scratching.

EQUITONE [tectiva]

With its uncoated true surface, most marks and stains, or even superficial scratches are easily removed by normal washing with mild detergents or soap solutions (e.g. dishwashing liquid) and a sponge. Stubborn stains and marks are usually removed by a light sanding of the surface with exceptionally fine grit sandpaper in the same direction as the surface texture or grain. Brush away any residual dust.

Fixing

Visible rivet fasteners

Stainless steel rivets can be used with aluminium, galvanised or stainless steel supporting frames.

Fixed point

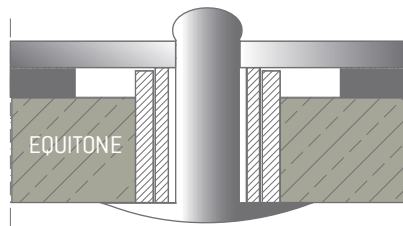

Drill an 11mm diameter hole in panel and 4.9mm hole in rail. Rivet sleeve used in conjunction with rivet.

Gliding point

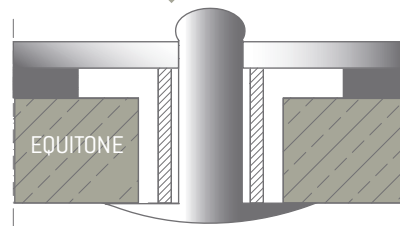

Drill an 11mm diameter hole in panel and 4.9mm hole in rail. Use only the rivet.

A centralising tool is used to drill the rivet hole in the supporting frame.

An option of using a rivet setting tool – fitted to the end of the rivet gun – can be used to minimise risk of scratching panel surface.

Hole positioning is as follows:

- from the horizontal edges of the panel, i.e. 70mm → 100mm, and
- from the side edges of the panel, i.e. 30mm → 100mm.

Some framing systems will only permit the rivet to be 40mm from the side edge. Placing corner rivets visually 80mm from the horizontal edge is the preferred location. Centres for the rest of the fixings are determined according to project engineer's wind load calculations.

All fasteners must be inserted perpendicular to the panel surface, and must not be over tightened to impede the free movement of the panel.

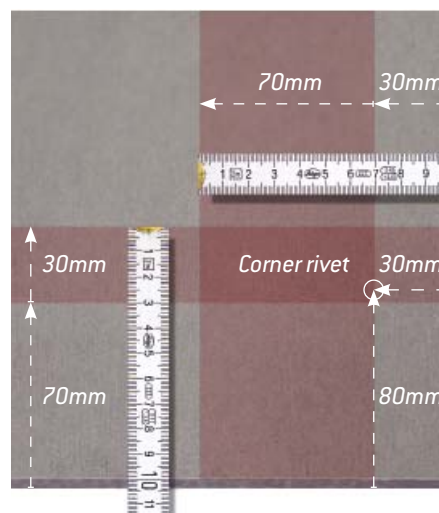

NOTE: When drilling occurs at project site, a template for hole positions is simple but useful tool that helps accelerate the process, particularly for corner holes. The template can be fabricated on site but extra care should be taken not to leave marks on the face of the panel.

Distances of rivet fasteners with respect to wind load

It is the responsibility of the installer to ensure that the metal support frame is installed in accordance to the structural engineer and metal support frame supplier's recommendations, specific to project requirements. EQUITONE panels, however, must be fixed in accordance with guideline below.

Design wind load	Maximum centre distances of rivet fasteners
≤ 1.2kPa	600mm
1.2–2.0kPa	500mm
2.0–2.5kPa	400mm
> 2.5kPa	300mm

As a general rule of thumb, above maximum distances between rivet fasteners must be respected.

Step-by-step panel fixing

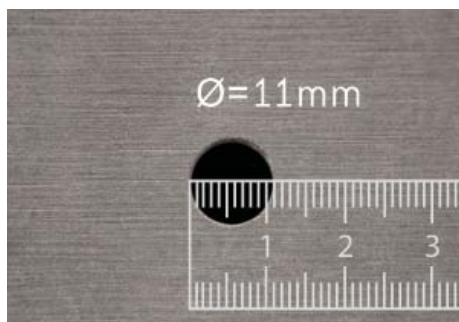

1) Place foam tape onto support frame metal profiles. Drill all holes in panel with 11mm diameter bit.

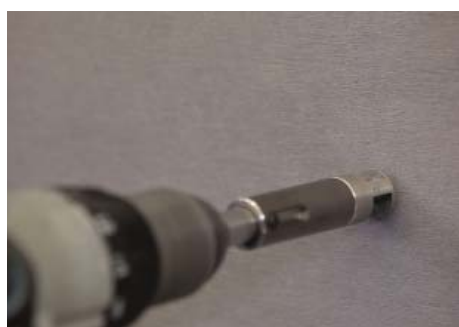

2) Starting with fixed points, insert 4.9mm centralising tool into holes and drill through support frame profiles. Remove any debris.



3) Fixed points: place rivet into fixed point sleeve and load into rivet gun. Insert rivet with fixed point sleeve into predrilled hole and pop the rivet.

4) Gliding points: continue with gliding points, insert 4.9mm centralising tool into holes and drill through support frame profiles. Remove any debris.



5) Insert only rivet into rivet gun and place into predrilled hole and pop the rivet. Fix gliding points after fixed points are completed.

Fixing

Fixing and gliding points

To allow for expected movement in the supporting frame, panels are fastened to the supporting frame with a combination of fixed and gliding points. All sizes of EQUITONE panel come with two fixing points and a few gliding points in adjacent position.

The two fixing points support weight of the panel and ensure panel stays in position and prevents rotation. The gliding or sliding points resist wind load while accommodating any panel or support frame movement.

The choice of where fixing points are located is important to minimise risk of panel cracking.

Selection of fixing points

Two fixing points should never occur on the same supporting frame (profile). The two fixing points must be located near the horizontal centre line of the panel. If there is no central fixing, use the next row closest to the centre line; the usual preference is for the higher line of fixing.

Two profiles are therefore needed. This is straight forward where there are at least two profiles in the middle area of the panel.

Most common, however, there is only one profile in the middle area of the panel. Hence, the rule of thumb is that fixing points are located in the centre of the panel and to the left joint profile. Alternatively they can be located to the centre and right joint profile. Which system is employed, all panels must be the same.

Under no circumstance should the fixing point of two adjoining panels occur on the same joint profile.

In situations where narrow panels with only two side fixings are used and the fixing points of adjacent panels will be next to each other, components of supporting frames will need to be changed. The metal frame behind the vertical joint which is usually a T or top hat profile will have to be substituted with two L-profiles or an omega profile. This will separate any panel connection.

Fixing point  **Gliding point** 

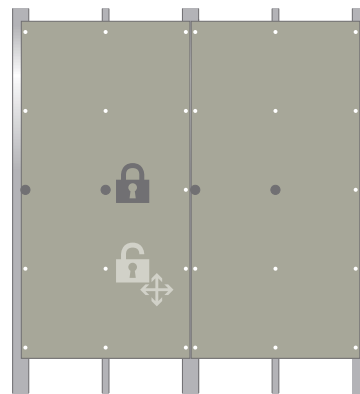

Example 1

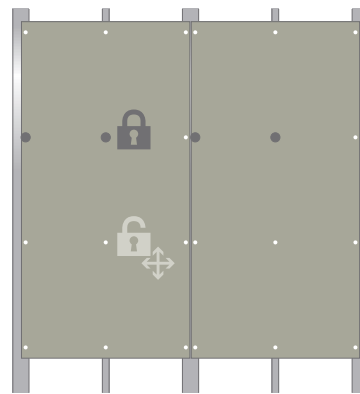

Example 2

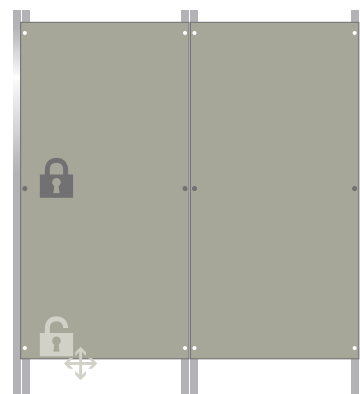

Example 3

Framing

Support frame

EQUITONE panels are strong yet light, reducing the amount of supporting frame needed when compared with other materials. Certification for the structural stability of any supporting frame should be in accordance with local building regulations and must be obtained by the building owner or official representatives, such as the project engineer.

Requirements

Whichever supporting frame is used, the wall should be checked by the installer prior to installation to confirm that it is flat and true, and that correct fixings and details are employed. Any discrepancy should be referred to the design team.

Structural design

All components of the external cladding must be designed according to the safety factors and permissible design load stipulated in national and local building and safety code regulations.

Support frame layout

The most common arrangement for panel support is onto metal supporting frames. Vertical profiles ensure that the air flow in the cavity space is not disrupted and that there is free drainage of any moisture.

Anchoring

Whichever supporting frame is used, the secure anchoring or fixing of the frame back to the wall is very important. The design and selection of the anchor to suite the wall substrate characteristics and the wind load should be based on engineering calculations, together with on-site tests. This is important with renovation projects, especially when the performance of the wall is unknown. These calculations will determine the amount of anchors required.

Many proprietary support frame systems have guidance of the secure fixing back to the structure.

Framing



Metal supporting frame

Metal supporting frames – whether aluminium, galvanised steel or stainless steel – are normally a locally sourced component. Typically, the supplier or installer of this type of framing will confirm specifications and performance characteristics, as well as provide detailed technical drawings. The following information is therefore provided as guidance only and should be verified for each project by the project engineer.

EQUITONE panels can be rivet fixed to metal supporting frames. Always use stainless steel fixings and fasteners.

Depending on local availability, standard supporting frame consists of vertical profiles in different widths profiles which support the EQUITONE panels.

Please refer to local regulations for the level and quality of aluminium, stainless steel or galvanised coating.

These profiles are normally fixed back to the main structure. However where a wider cavity is required angle brackets can be used to support the vertical profiles.

Specification









Wider profiles are used behind vertical joints between panels while a narrower profile is used as intermediate profiles in the middle of the panel. It is advisable to use a vertical profile that allows for tolerance and any discrepancy in component layout and installation dimensions.

Minimum profile thickness	Aluminium	≥ 2.0mm
	Galvanised/stainless steel	≥ 1.15mm
Minimal depth of profile		≥ 35mm
Minimal width of intermediate profile		≥ 40mm
Minimal width of vertical joint profile		≥ 90mm
Recommended width of joint profile		≥ 120mm
Maximum buckle under influence of strain		≤ Span/250
Safety factor calculation of strength		3
Maximum length of vertical profile		6m
Movement joints between adjacent profiles		20mm
Maximum unsupported length from last bracket/anchor		250mm

Continued on opposite page

Specification

Table below summarises the common metal sections that are available.

Position	Section
Vertical joint profiles	Rectangular or square hollow 
	T-profile 
	Top hat, furring channel or Omega profile 
Intermediate profiles	Rectangular or square hollow 
	L-profile 
	C-profile 
	Top hat, furring channel or Omega profile 
	Z-profile 

Framing

Movement of supporting frame

Allowance for any expansion and contraction of the metal supporting frame needs to be taken into account in the overall design of the system. The principle of fixing and gliding points is a good one and where possible is recommended for all metal supporting frames. This is particularly relevant in ecologies that experience climatic extremes and big variations in temperature.

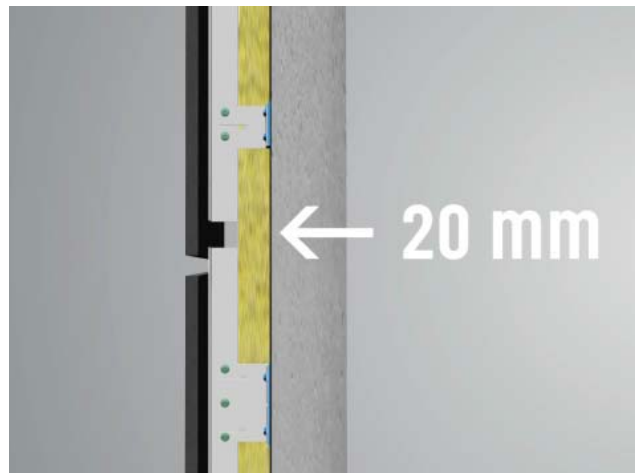

1. Joints between profiles must also coincide with horizontal joints between panels.
2. A minimum 20mm gap should be allowed between profiles.
3. Joints in profiles should be at same levels around the building envelope.

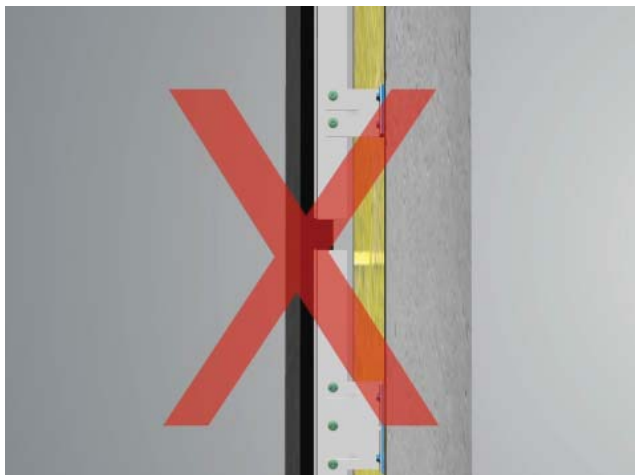

4. Panel is never fixed to two separate profiles.
5. Movement in profiles may cause panel to crack.

Panel layout

While design of the supporting frame is calculated around wind load the facade is likely to experience, another important factor is the actual panel layout desired by the architect. The panel layout can exert a big influence on the amount of large or small profiles required by the project.

Other influences on the supporting frame layout include staggered panel joints or totally free patterns which use different size panels in a random layout. These considerations can result in the use of all large profiles.

Vertical layout: aligned grid pattern

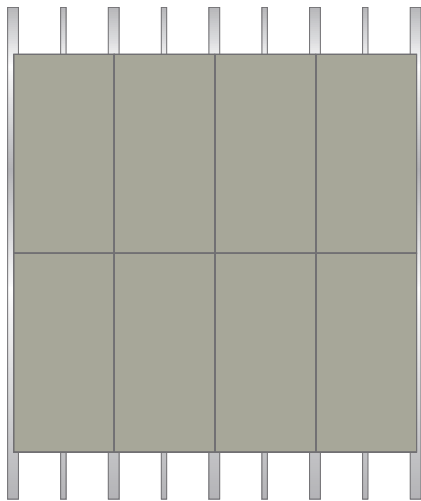

Horizontal layout: aligned grid pattern

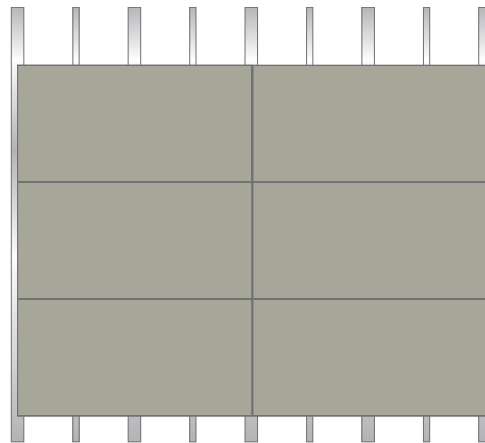

Vertical layout: staggered grid pattern

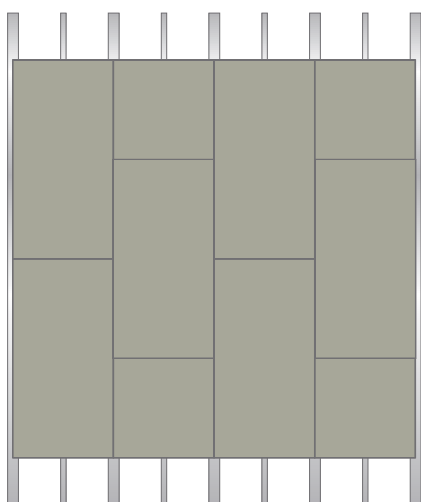

Horizontal layout: staggered grid pattern

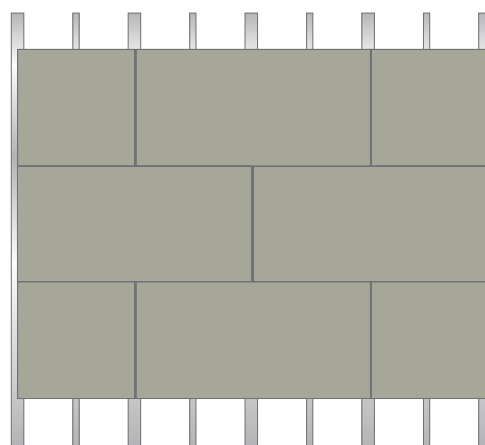

Panel layout

Ventilation

A through flow of air is achieved by utilising the stack-effect, in which a current of air enters at the base of the cladding and exits at the top.

In addition to necessary ventilation to cavities at the top and bottom of the facade, it is also important to allow air to enter and exit under and over openings such as windows.

These openings need to be protected against entry of birds and vermin into the cavity space.

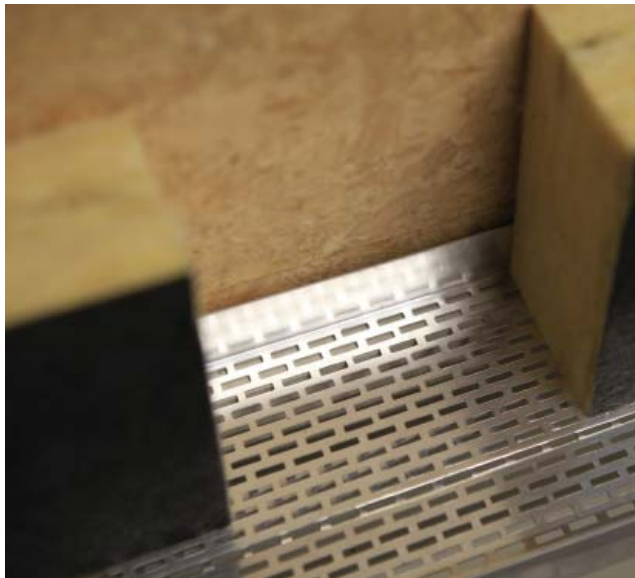

Failure to protect against these natural phenomena can cause damage to the backing wall.

Effective protection is normally achieved by fitting a perforated profile. It is vital that perforations are sized correctly, to allow air in and out while preventing entry of vermin.

A minimum free space of 10mm/m or a 100cm² per linear metre is recommended.

To compensate for the perforated profile, which can reduce air flow by 50%, and other building irregularities, the gap should be at least twice what is theoretically required.

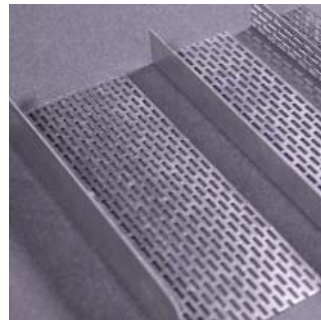

Panel joints

Normally two types of joints are used between panels.

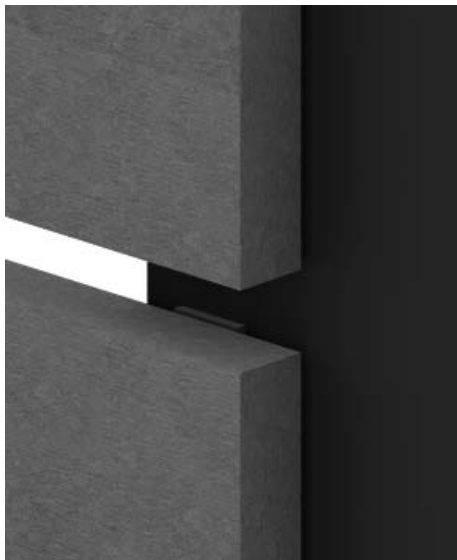

1) Open joints in which there is a clear open gap between edges of adjoining panels.



2) Closed joints where a horizontal joint profile is used to block the direct line through the joint.

NOTE: Sealed joints where a gasket or wet applied sealant is used to fill the joint and make it water-tight and air-tight is never specified with EQUITONE panels. This can result in unsightly staining and the sealant losing its colour.

Closed horizontal joints

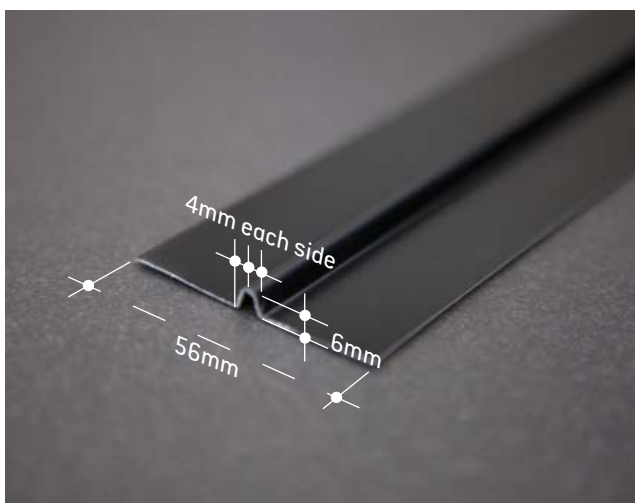

When a horizontal joint required to be closed, a metal joint profile of maximum 0.8mm thickness can be inserted behind panels.

By using a joint profile the majority of water is prevented from entering the cavity. In some buildings it is advisable to have closed joints, such as the low areas of public or educational buildings. The joint profile will prevent debris from

being deposited behind the panels. In the case of kindergartens, baffles will prevent small fingers from getting stuck in the joints.

Continued on next page

Panel layout

Closed horizontal joints

Continued from previous page



1) Before final fixing of the lowest rivets on a panel, the profile is slid up under the panel.

2) When fasteners are tightened, the profile is held in place. At the junction with a vertical joint the profile can be trimmed to maintain a pleasing vertical joint appearance. The profile can be cut approximately 4mm narrower than the width of the panel, leaving the profile 2mm shorter at each side.

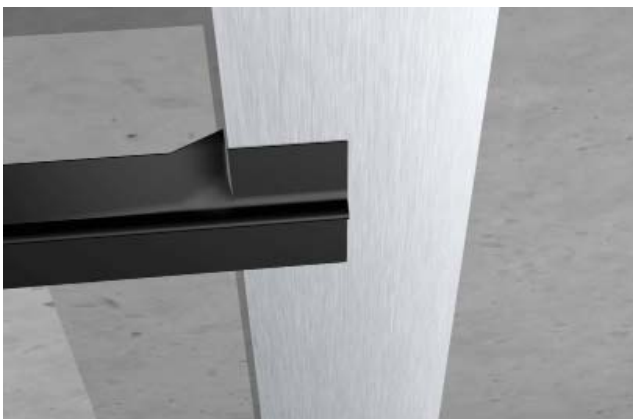

3) To prevent sideways movement of the joint profile, and exposing that movement at vertical joints, cut and bend top or bottom edges of the profile at both sides of one of the vertical support profiles or battens.

Open horizontal joints

By leaving the joints open, the likelihood of dirt spoiling the facade reduces as the joint remains clean. The open joints also function as additional ventilation openings. An open joint also has the effect of reducing wind load on the facade panel. Therefore, it may be possible to reduce the number of fasteners.

Remember the supporting frame is visible with open horizontal joints. The joints may need to be concealed using black profiles, paint or tape.

Joint width

Many years of practice have shown that the optimum width of the joints between large panels is 10mm. This also offers the installer a reasonable level of tolerance when setting out the frame and fitting the panel. The minimum permissible joint width is 8mm while the maximum would be 12mm.

Vertical joints

Vertical joints are backed with a continuous profile. When a metal supporting frame is used, the grey or silver colour can be prominent, especially when used with dark coloured panels. This could be an unappealing feature. To eliminate this potentially unattractive feature, the best solution is to simply “black out” the joint.

The “black out” of a joint can be achieved by using black UV light resistant wide foam tape. If the foam tape is an integral part of moisture management design strategies, the tape must be compressed between panel and profile. To prevent distortion of the panel at mid fixing points, the foam tape needs to be placed on smaller top hats.

When narrow strips of foam instead of one wide strip are used, place one continuous strip to each side of the open joint. The visible metal can then be simply taped or painted to help conceal it. Alternatively, coated metal profiles can be considered. Make sure profiles are prepared correctly before painting or taping as new metal profiles can have an oily surface. To prevent distortion of the panel at mid fixing points, foam tapes need to be placed on the smaller top hats.

NOTE: The functional life of painting or taping profiles on site is not as long as anodised metal profiles.

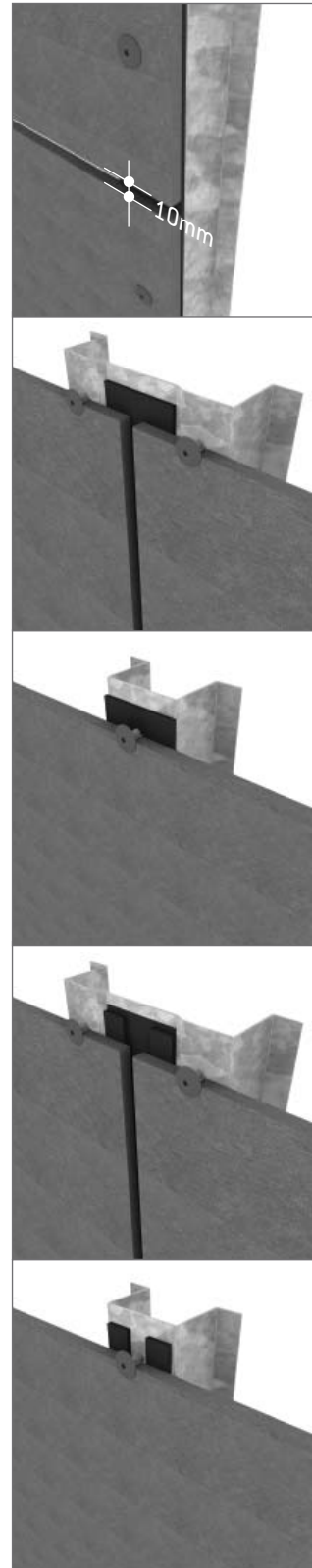

Others

Sub-structure – lightweight wall

A lightweight structure of metal or timber stud is a form of backing wall. This can be a full structure or an infill wall between concrete floors.

It is the responsibility of the project engineer to ensure allowance for any movement in the frame and that the structure is properly accommodated with all the specified connections.

The face of the sub-structure requires appropriate quality sarking or sheathing to provide suitable management of moisture ingress. It is the responsibility of the designer to specify a suitable moisture management system.

For open jointed systems, this sarking must be a solid fibre cement building board that also act as a “wind shield”. The board may be required to offer some frame racking resistance or fire resistance should be sized correctly. This wind shield must be airtight and this can be achieved by taping joints with suitable long lasting tape.

Windows, doors and other penetrations

Whether the main structural wall is a timber/metal lightweight frame or a massive masonry construction, the wall should be watertight and airtight, particularly around openings such as windows or doors. Before fixing the support frame or panels, all penetrations must be properly sealed.

Air tightness prevents moisture ingress and ensures the building remains thermally efficient. Fix the windows or doors to the backing wall and seal the edges with appropriate materials to reduce the risk of any moisture ingress. All material or flashings and their installation must comply with the relevant standards and building codes.

Movement joints

The term “movement joint” or “expansion joint” refers to the isolation joints provided within a building to permit the separate segments of the structural frame to expand and contract in response to temperature changes without adversely affecting the building’s structural integrity. In simple terms, movement or expansion joints relieve stress on the structure. Failure to incorporate these movement joint gaps into the structure can result in cracking under structural stress.

The size and location of any movement joint is related to the choice of structural building materials and local climate conditions. The ventilated facade has its own built in movement joints, with its combination of fixed and gliding points. However, the main building movement joints must be continued through to the external face of the panel. The ventilated facade cladding should not be fixed to both sides of the structural movement joint.

Cavity

The cavity is a primary feature of a ventilated facade. It is designed to act as a pressure cushion to prevent water from reaching the backing wall. By ventilating the cavity, moisture that arises from water passing the panel, moisture migrating from the inner surface of the wall or the action of condensation will be removed either by evaporation, or simply running down the back of the panel. In the event, moisture escapes out and away from the backing wall.

Cavity width

It is generally considered that the minimum cavity width should be at least 20mm immediately behind the back of the panel. However, this is only suitable for low rise buildings with open joints. As the facade gets higher, the cavity needs to increase in width.

The type of joint used between the panels will also have an influence on cavity width. Open horizontal joints will allow more air movement than closed joints. A wider cavity may therefore be considered with closed joints.

Generally, the recommended cavity width with closed joints is as below:

Building height	0–10m	10–20m	20–50m
Minimum cavity width	30mm	40mm	50mm

NOTE: On renovation projects, when designing the width of the cavity, it is important to make allowance for tolerance. Building irregularities, especially uneven backing walls, must never compromise the width of the cavity. This is critical when a horizontal support frame is incorporated into the cavity space.

A sequence or method of placing EQUITONE panels on the facade must be followed to minimise the risk of damage to the panels. The installer needs to survey the main supporting structure, checking line, level and fixing points. At the same time, the installer must also set out datum points, lines and levels for a complete elevation view.

Please refer to the project architects elevation drawings for layout of joints and line of fasteners. Note the relationship between the fixings and openings such as windows.

Experience indicates that the best sequence in placing EQUITONE panels that are face fixed is to commence at the top of the facade and work downwards.

Top-down method

This method brings a number of benefits to the installer:

- using the support rail ensures accurate joints,
- support rail acts as additional workman,
- reduced risk of dirty panel as installer works away from installed panel,
- reduce risk of damaging panel by working on scaffold, and
- reduces time required to clean facade.

1) Starting at the top of the facade, mark bottom edge of the top panel on the profiles. Align this position mark across the facade. Temporarily clamp a metal support rail across profiles. This support rail will act as another workman and carry weight of the panel, allowing easy adjustment prior to fixing. Lift first panel on to this rail and position into place. Securely hold or temporary clamp panel into position.



2) Always fix central fixing points or middle points first to hold panel in place, and then work outwards towards edges with other fasteners. Remember, if a horizontal joint profile is in use, do not fix bottom row of fasteners at this stage.



3) Lift and slide next EQUITONE panel into place. Use 10mm spacers of a type not to cause damage when being removed, and to create a consistent vertical joint gap. Fix this panel as with first panel and continue across facade, moving the support rail as work progresses. With the top row in place, remove support rail.



4) Measure down from bottom edge of the upper fixed panel and mark position of bottom edge of next row of panels. This measurement is equivalent to the height of the panel plus the horizontal joint (panel +10mm).

Using this new level, temporarily fix the metal support rail across the profiles again. This is the time to insert the horizontal joint profile. Slide the profile into place and then fix the missing fasteners in the panel above. These will hold the profile in place.

Continued on next page

Continued from previous page

5) Lift the first panel of this row on to this rail and position it into place, aligning panel vertical edge with edge above. Repeat fixing sequence for the panel. Continue working across facade. The complete procedure is then repeated sequentially down the facade of the building.

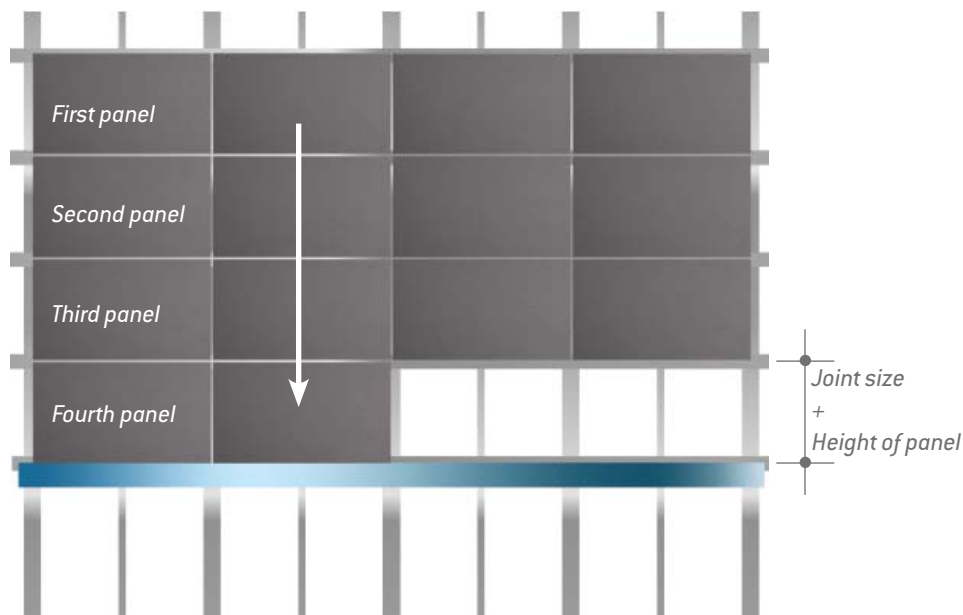

Facade scaffolding can also be stripped down as cladding proceeds, ensuring no future damage will occur from other trades. Position any trim profiles and any flashings as work proceeds. Ensure all movement joints are correctly formed. Repair any panel damage or defects as quickly as possible.

Special situations

It is sometimes necessary, for limited applications, to commence cladding from the base of the facade. This can be done successfully but requires the installer to take extra care and attention to prevent damaging panel edges. The most likely damage will be the top edge of the lower panels because the weight of the upper panel rests on the spacers. These in turn rest on the lower panel. Removal of joint spacers must therefore be achieved with utmost care.

One suggestion is to use an 8mm spacer and wrap a 1mm rubber strip around the top face, back edge and bottom face of the spacer. Remove the spacer first and then the rubber strip. The rubber strip protects the edges of the panels as the spacer is removed.

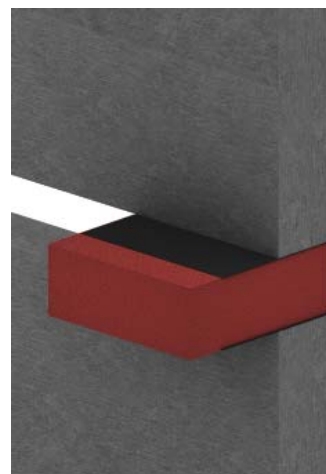

Base details

1. EQUITONE panel
Ends of panels are typically positioned a minimum 150mm above the finished ground level. This will help prevent rain splash-back from the ground while maintaining sufficient space for the air to enter the cavity. No planting of garden, decorative or ornamental plants should be allowed near the air inlet, over time these may block air inlets.
2. Metal support frame
It is recommended that the panel overhangs support profiles and perforated profiles by 20-50mm, forming a drip to all rainwater to fall away from the building. The bottom row of panel fixings should be between 70-100mm up from the bottom edge of the panels.
3. Perforated profile
The space between the panels and the wall must have a perforated profile fitted. This allows air to enter the cavity space while preventing the entry of birds or vermin. Fix the perforated profile to the vertical profile and ensure it extends to within 5mm of the backing wall.
4. Drip flashing
Drip flashing can be used to protect junction between the concrete and the metal structure.
5. Sarking should lap over the drip.

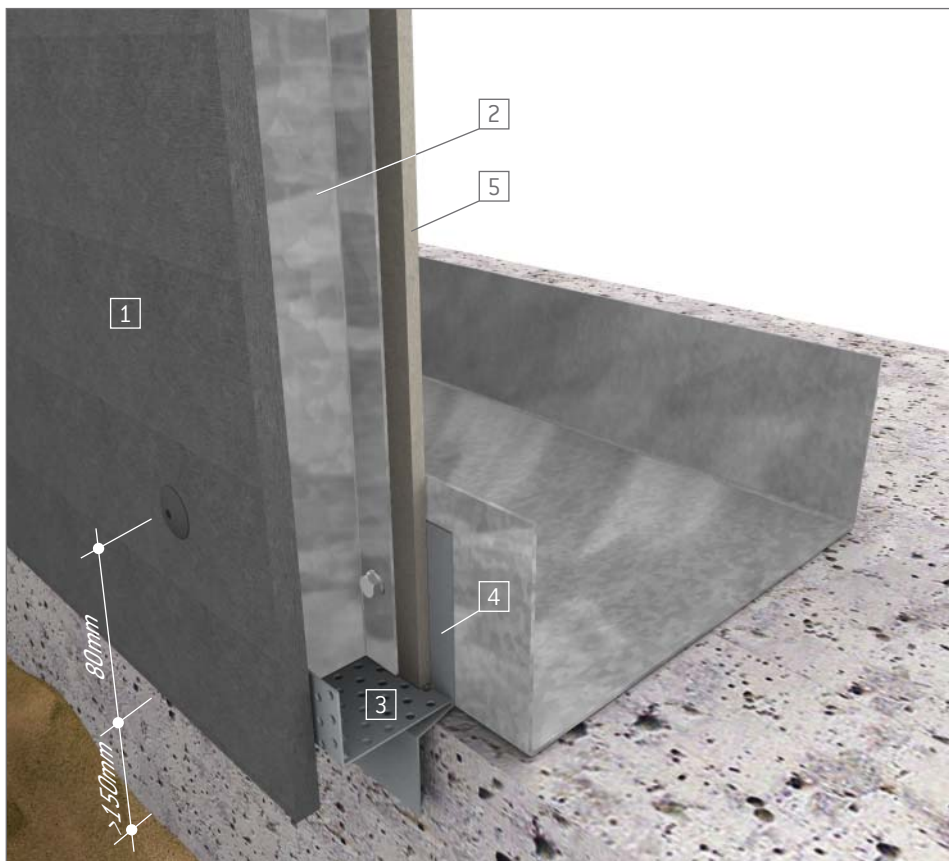

Parapets

1. EQUITONE panel
Panel fixings can be placed between 70-100mm from the top edge of the panel.
2. Metal support frame
3. Gap to allow air to escape
Air must be allowed to exit the cavity behind the parapet capping. A perforated profile can be used to prevent entry of birds or vermin.
4. Air tight seal
5. Sarking
6. Metal capping
A 20-50mm gap should remain between front of panel and the front edge of the capping, depending on the height of the vented wall. The front edge of the capping must offer adequate cover to the panels and provide a minimum of 50mm protection.

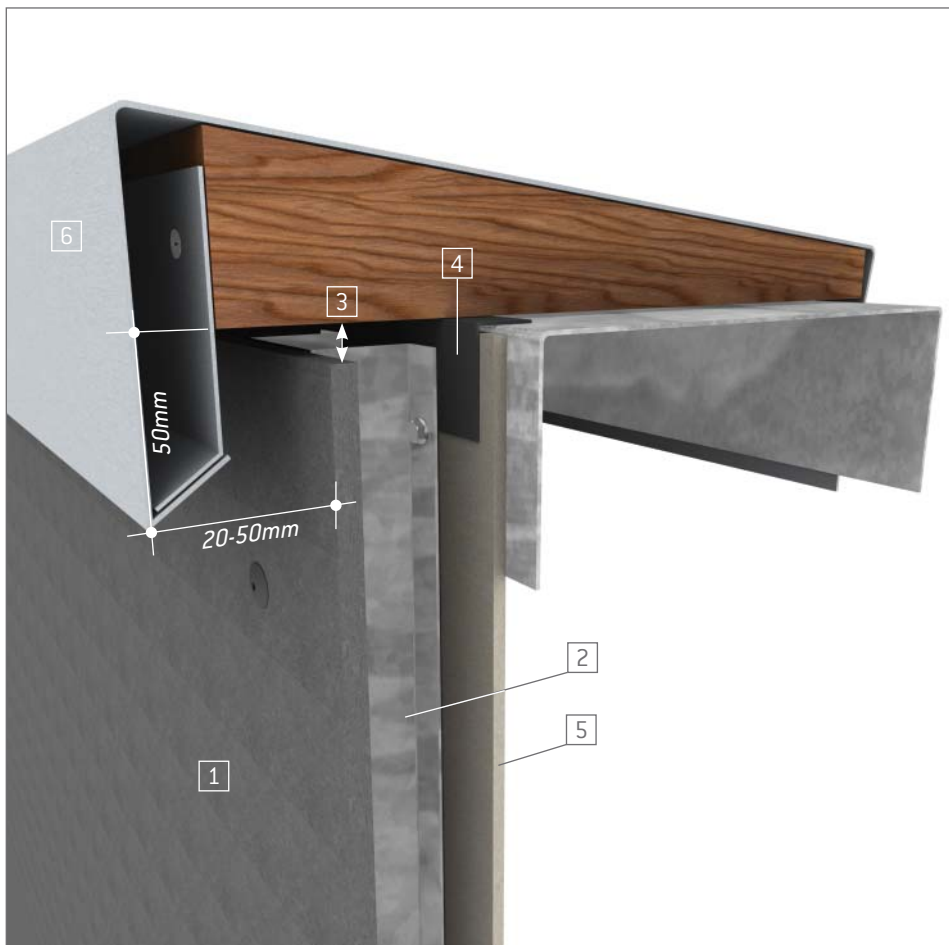

Window sills

1. EQUITONE panel

2. Metal support frame

3. Sill

Air from the cavity must be allowed to exit under the sill. A minimum 10mm gap should be left between the panel and the base of the sill. A perforated profile can be used for wider gaps to prevent entry of birds or vermin. The front edge of the sill can be between 20-50mm away from the front of the panel and offer adequate cover to the panels. This provision ensures that water is thrown away from panels.

4. Air tight seal

5. Sarking

6. Window profile

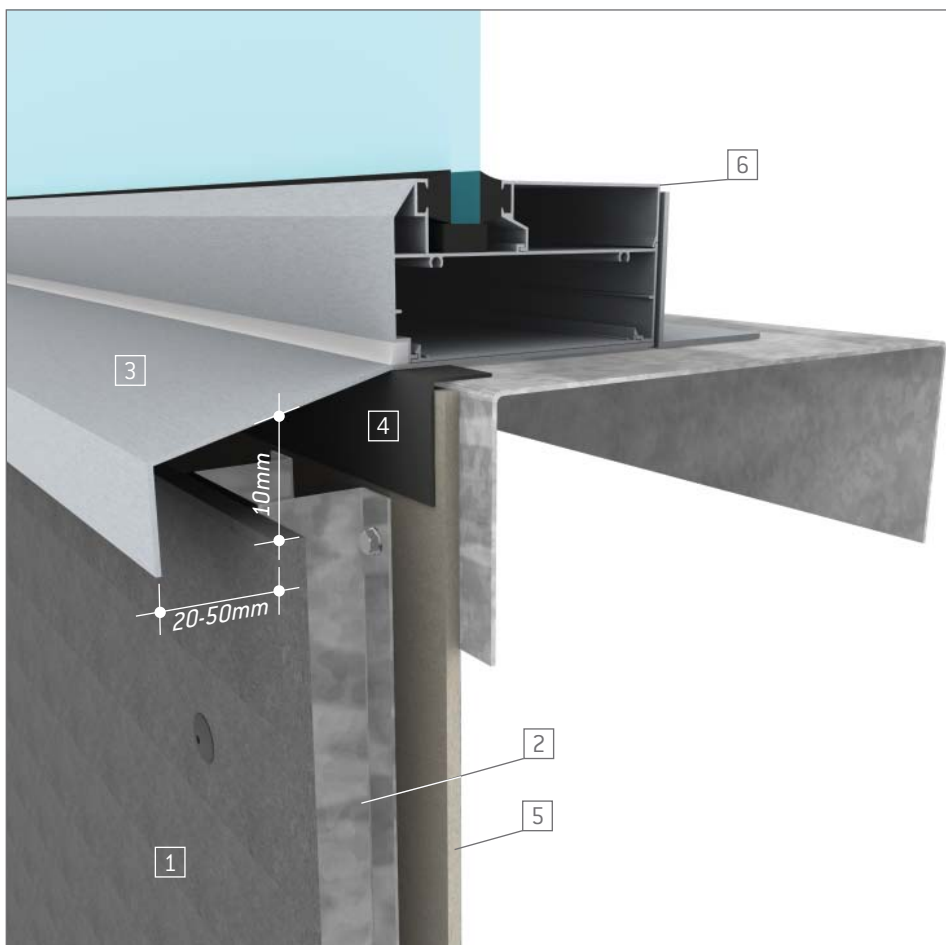

Window / opening heads

1. EQUITONE panel
2. Metal support frame
3. Perforated profile
Air must be allowed to enter cavity above heads of windows, doors and other openings. A perforated profile can be used to protect the opening from the entry of birds or vermin. To help conceal the perforated profile, the installer can paint it black prior to fitting.
4. Drip flashing
5. Sarking
6. Window profile

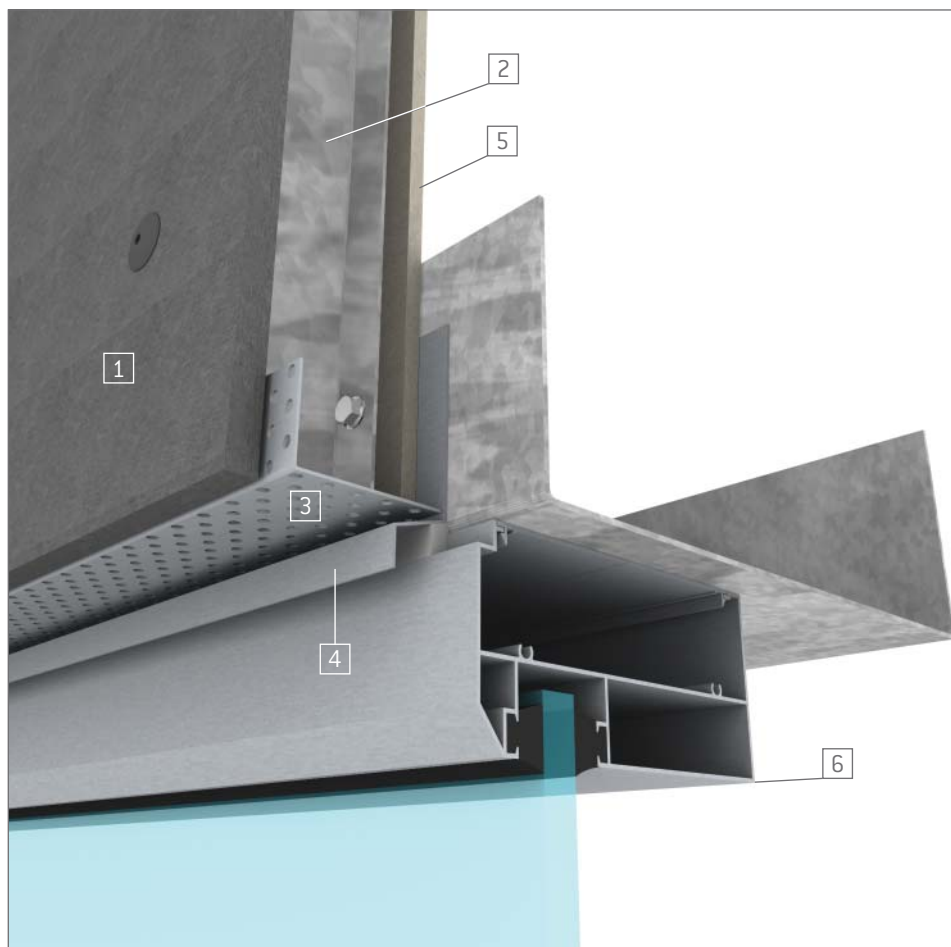

Window / opening jambs

1. EQUITONE panel

2. Metal support frame

3. Flashing

The ends of the window sill must be returned up behind the panel or the flashing at the reveals to offer adequate protection from moisture ingress. For wide reveals an F-profile accessory can be fixed to window frame to hold end of panel secure; the front edge of the reveal panel can be fixed to the support frame corner profile. For narrow reveals, specialist flashings as part of the window are generally considered to be the best option.

4. Air tight seal

Use appropriate seals between the window and the flashing piece.

5. Sarking

6. Window profile

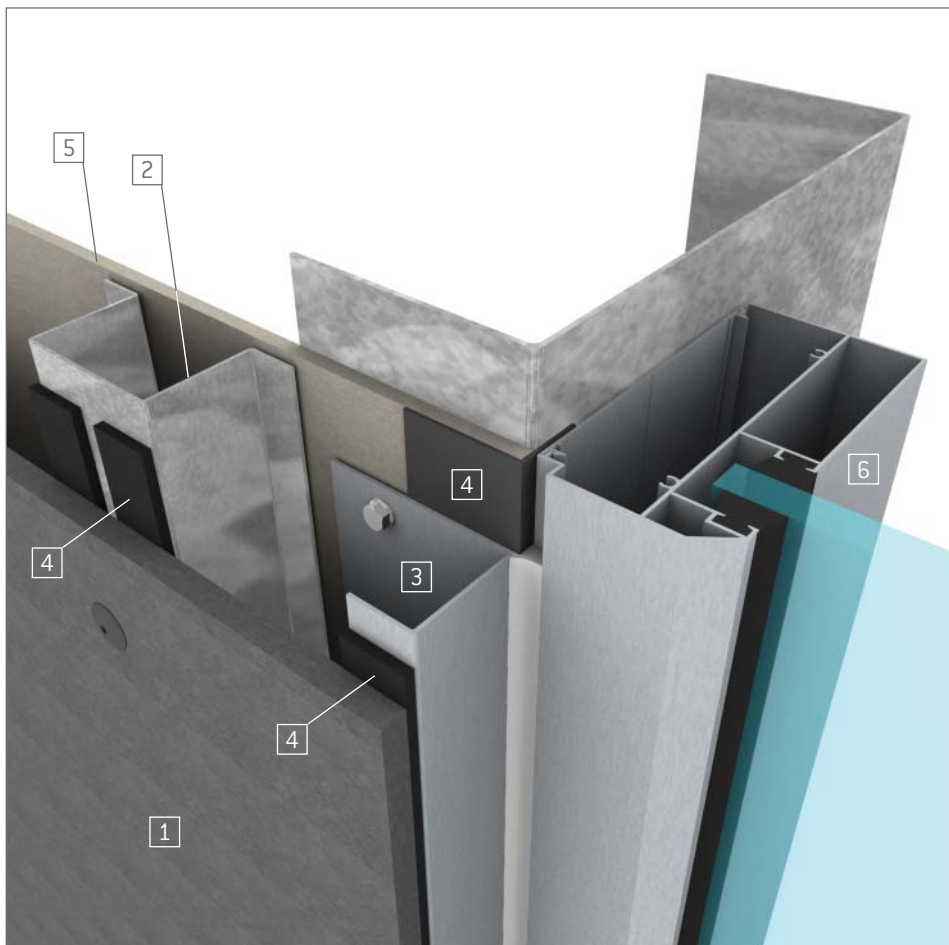

External corners

1. EQUITONE panel
2. Metal support frame
3. Metal corner support
Open joints typically employ 75mm x 75mm angles to support panel edges. Where this angle cannot be fixed back to the wall, provide panel support within 350mm of the corner. Joints in the corner profiles must coincide with support frame expansion joints.
4. Wall profile
5. Sarking

NOTE: External corners may be left as open joints or fitted with a proprietary trim profile. Trim profiles need to be fully supported on angle profiles.

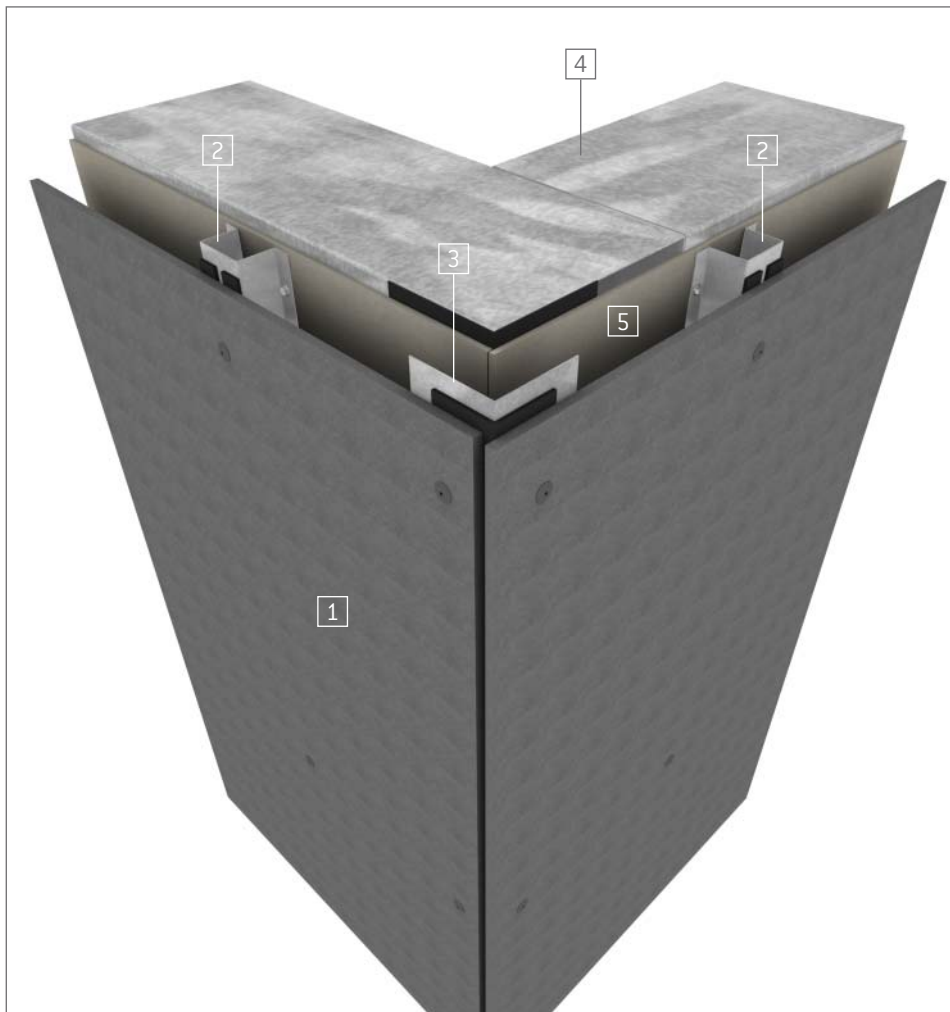

Internal corners

1. EQUITONE panel
2. Metal support frame
3. Metal corner support
A 75mm x 75mm angle profile can be used to support panel edges.
4. Wall profile
5. Sarking

NOTE: Internal corners may be left as open joints or fitted with a proprietary trim profile. Trim profiles need to be fully supported on angle profiles.



Expansion joints

1. EQUITONE panel

2. Metal support frame

3. Building expansion joints

For the building structural expansion joints, the panel must not be fixed across or crossing over these expansion joints. A piece of metal flashing can be fixed at one side to cover the expansion joint for metal purlins. A propriety foam strip or joint seal can be placed to fill the expansion joint for concrete floors or slabs.

4. Panel expansion joints

There is no special requirement for expansion joints with the panels as there is a gap on all sides and the fasteners allow for movement. Coordinate vertical joints in facade panels with that of the position of the expansion/movement joints. An additional vertical profile is used to support one of the panels. The larger profile allows this panel to slide. The gap left between the panels must be equal to that of the structural wall.

5. Sarking

6. Wall profile

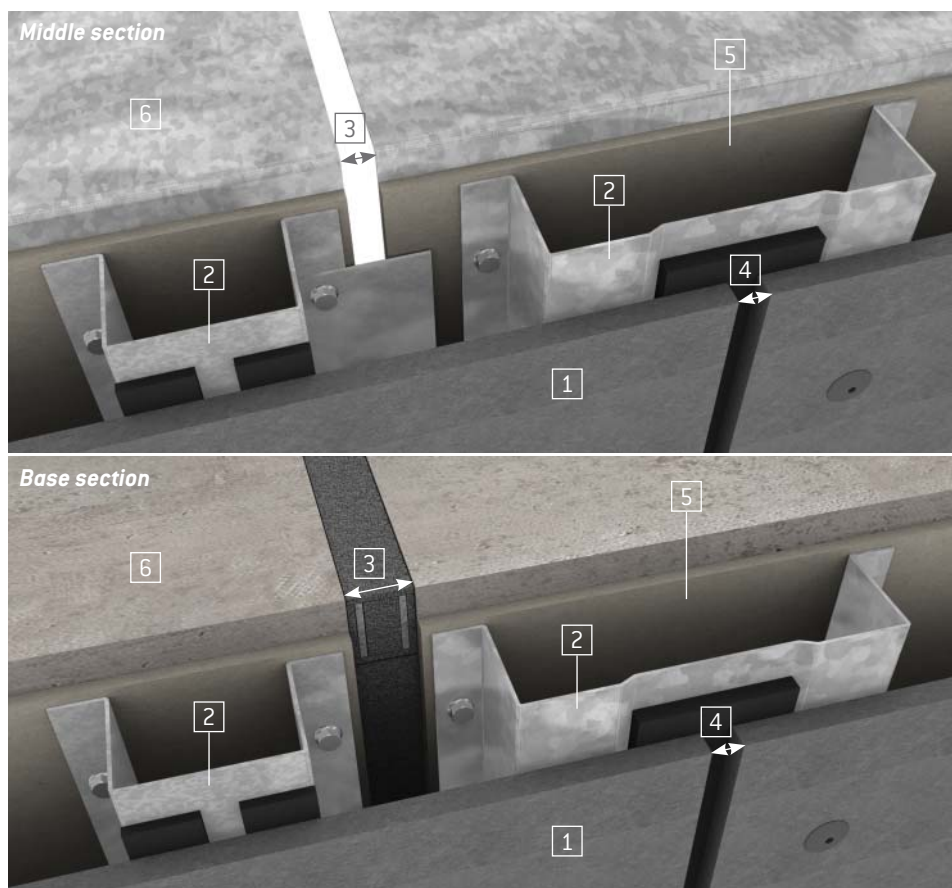

A number of basic principles are overviewed here. Cleaning must always take place in accordance with the recommendations of the supplier of the cleaning system and under their supervision and guarantee.

Inspections

All facades, irrespective of the material used, should be inspected and if necessary serviced regularly. Then, unnecessary and high costs are avoided in the long term. The building also retains its continuous and attractive appearance. If general soiling is allowed to work into materials for too long, it is possible that it will penetrate so deeply that simple cleaning is no longer possible. More rigorous and thus more expensive cleaning methods may have to be employed.

Soiling process and metal cover flashings

Dust, soot, oils, greasy substances and atmospheric grime etc are ever present in the air and rainwater, and can be deposited on most facades. If care is taken through considerate design and application, local soiling and runs can be avoided. This can be achieved by having adequate drip-moulding, such as overhanging window sills, good sealing and attention to combat corrodible materials such as zinc, copper, aluminium, steel etc. The degree and speed at which materials become soiled largely depends on the surface, chemical stability, hardness, porosity and ability to become electrostatically charged or not.

Graffiti

The UV-cured **EQUITONE** [pictura] and [natura pro] surface coating provides superior protection against common colours and spray paints. It is smooth and cleanable. The **EQUITONE** [pictura] and [natura pro] surface coating meets the requirements of the placement test and test cycle 2 of the quality association for anti-graffiti eV for surface-protective anti-graffiti. Please refer to ILF 4-013/2006 report of the Institute For Paints And Inks eV.

Graffiti can be removed with dedicated graffiti removers. Cleaners with volatile solvents should not be used. Below is a selection of appropriate graffiti removers. The application instructions of the manufacturers should be followed precisely, e.g.

- Costec Technologies and Cleaner Liquid Cleaner Technologies, www.costec.eu
- Scribex P3 400, www.henkel.de
- Rapidly 031, e-mail: pregernig@t-online.de

NOTE: When an on-site graffiti protection is applied to the panels the appearance of the panel may change as the protection effects the light reflectance of the panel's colour.

Cleaning

There are two methods of cleaning facades, mechanical cleaning and chemical cleaning. In principle, perform the cleaning of the facade over the entire surface, because partial cleaning can result in colour and tonal imbalance. Normal stains can be removed with a sponge and water. The use of abrasive materials such as scourers and steel wool etc is not permitted, as these leave irreparable scratches on the panel surface.

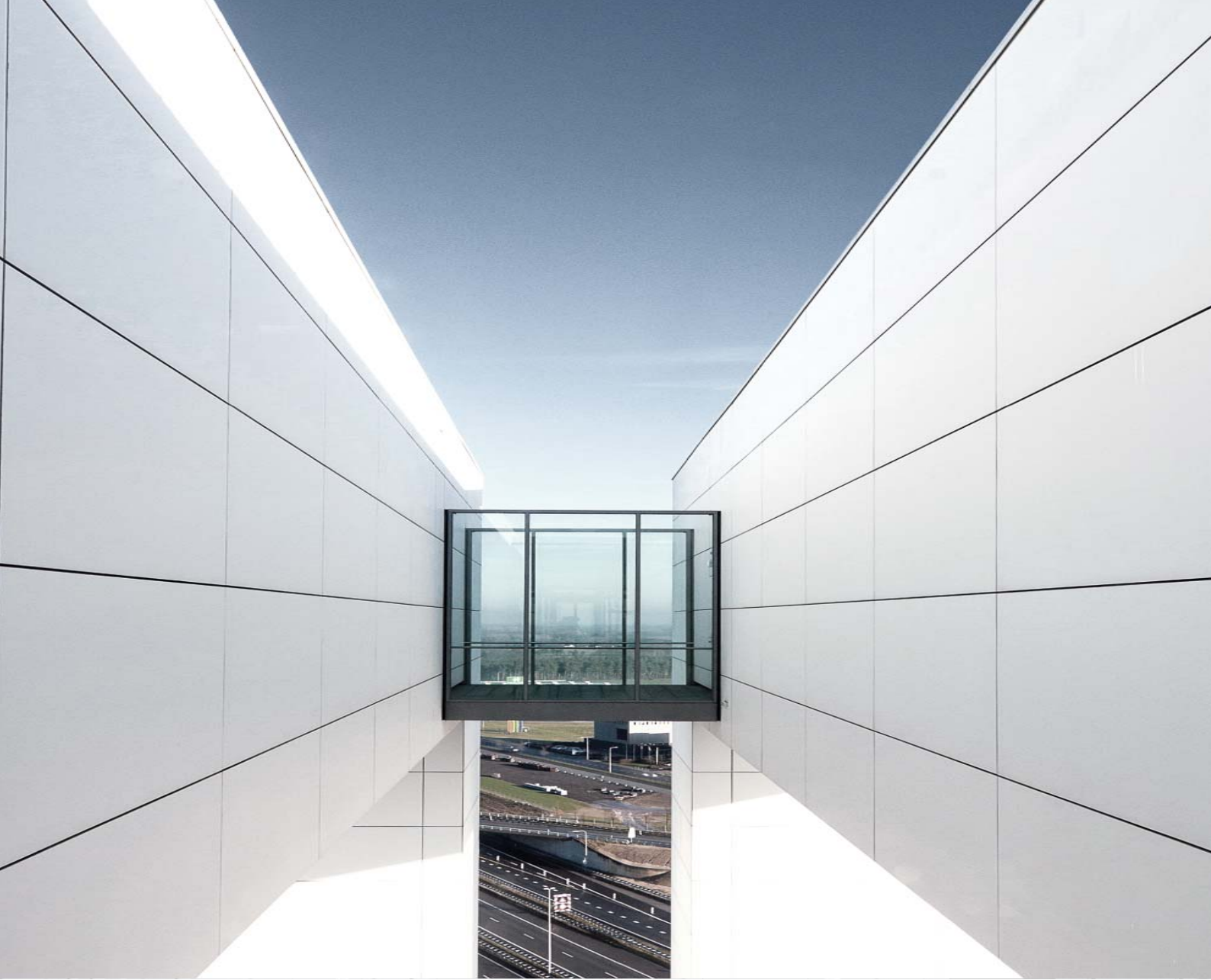

- Eternit Asia Panels warrants its EQUITONE materials to remain free of defects in material and manufacture for 10 years from date of purchase. In the event of any failure of the products caused by the direct result of a defect in the material or manufacture of the product, Eternit Asia Panels will at its option replace or repair, supply an equivalent product, or pay for doing one of these.
- This warranty does not apply where the product has been used in any manner not in accordance with the manufacturer's instructions, nor the reuse of the product after its initial installation. This includes installation and maintenance in accordance with this technical manual. Eternit Asia Panels recommends that only those products, components and systems recommended by it, be used. The project must be designed and constructed in strict compliance with all relevant provisions of the current Building Code of Australia, regulations and standards.
- All other products, including coating systems, applied to or used in conjunction with the product must be applied or installed and maintained in accordance with the relevant manufacturer's instructions and good trade practice. Eternit Asia Panels will need to be satisfied that any defect in its product is attributable to material or manufacture defect (and not another cause) before this warranty applies.
- Notification of a warranty claim must be made to Eternit Asia Panels prior to any return or attempted repair of the product. Failure to allow Eternit Asia Panels to examine an alleged faulty product in situ may result in the voiding of this warranty.
- Eternit Asia Panels will not be liable for any claims, defects or damages arising from or in any way attributable to poor design or detailing, poor workmanship, movement of materials to which the product is attached and/or incorrect design of the structure settlement or structural movement, high levels of pollution and/or acts of God. The latter includes but is not limited to floods, cyclones, earthquakes, other severe weather or unusual climatic conditions and/or performance of paint/coatings applied to the product and/or normal wear and tear.
- Other than as expressly set out in this warranty, and the guarantees that cannot be excluded under Australian Consumer Law "Schedule 2 of the Competition and Consumer Act 2010 (Cth)" (and any other law), Eternit Asia Panels excludes all other warranties and guarantees with regard to product, including all guarantees and warranties that might apply by law.
- To the extent that it is able to do so, Eternit Asia Panels excludes all liability for loss and damage (including consequential loss) in connection with the product. This exclusion does not apply where the product is sold to a consumer and is a good of a kind ordinarily acquired for personal, domestic or household use or consumption.
- The following statement is provided where the product is supplied to a buyer who is a "consumer" under Australian Consumer Law:
 - a) Eternit Asia Panels products and systems come with guarantees that cannot be excluded under Australian Consumer Law.
 - b) Users of Eternit Asia Panels goods are entitled:
 - i) to a replacement or refund for a major failure and for compensation for any other reasonably foreseeable loss or damage, and
 - ii) to have the goods repaired or replaced if the goods fail to be of acceptable quality and the failure does not amount to a major failure.
- The benefits of this warranty are in addition to other rights or remedies of the consumer under law in relation to the goods or services to which the warranty relates.



EQUITONE
Fibre cement facade materials



www.equitone.com

EQUITONE Asia Pacific

info.asia@equitone.com

info.australia@equitone.com